

# PRACTICAL GUIDE

## Antenna systems

### Principle of protection against lightning and surges

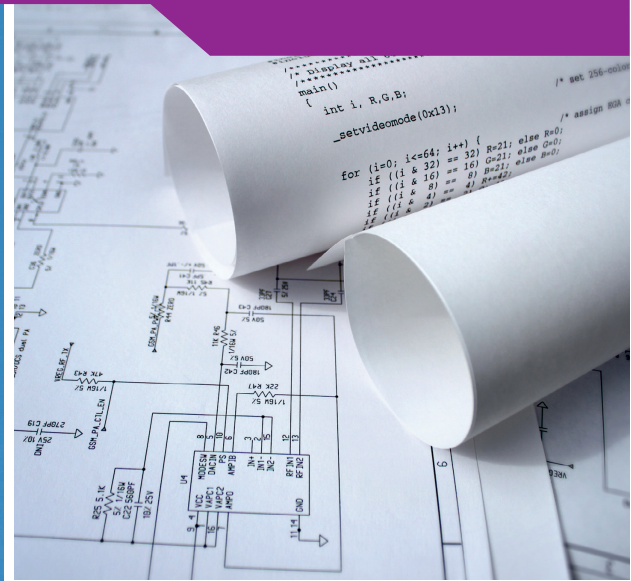

## Introduction

As regards the principle of functioning, antenna systems are devices that are, with a few exceptions, placed at sites exposed to atmospheric disturbances (storms). Therefore they automatically turn into devices that are at risk of thunderstorm activities and are exposed to adverse potentials arising from lightning, induction of nearby lightning strikes or from faults on medium voltage or high voltage power lines.

Antenna systems are electrically connected to a transmitter or receiver and these electronic devices are sensitive to various electromagnetic disturbances. Therefore, if we want to make these devices working reliably, it is necessary to ensure their maximum resistance to atmospheric disturbances and possibly disturbances arising at low and high voltage lines situated in the vicinity of antenna systems. From this it follows that it is necessary to secure these systems against lightning as well as against the induced voltage.

This issue is addressed by a set of EN 62305 standards in accordance with the EN 60728-11 standard, ed. 2.

The EN 60728-11 standard ed. 2 shows in detail the basic principles of placing the antenna systems on building objects (buildings) and their protection against direct lightning strike, protection against induced surges, including the solution of bonding and grounding issues.

The basic rule to protect antenna systems is their location which is to be situated in an area protected by LPS (the LPZ 0<sub>b</sub> zone) while maintaining adequate distance. This separation (isolation) distance „s“, which is between the antenna system and a trap (ATS – air terminal system) system or LPS (lightning rod) or any associated portions of the LPS, must meet or exceed values required by EN 62305-3.

Antenna systems are not allowed to be installed on buildings having a roof covered with easily flammable materials such as reed, thatch, bitumen board etc. Antenna down leads (coaxial cables, etc.) and grounding conductors must not be routed through areas where flammable materials such as oil, straw, hay and similar materials are stored, or through the spaces in which explosive gases may arise or accumulate (e.g. carpentry workshop).

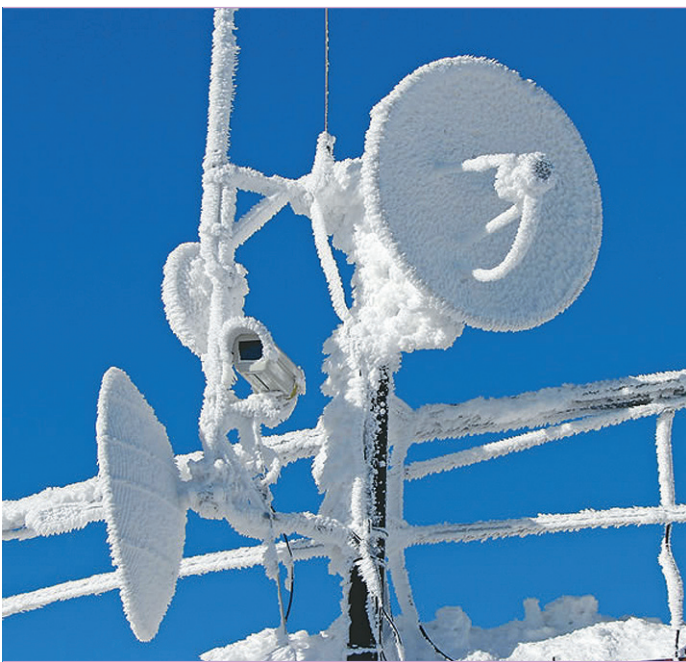

## Protection against lightning

### a) Building objects provided with protection against lightning (LPS)

If a building is equipped with the LPS system (lightning rod), which corresponds to EN 62305-3, it is necessary to install the antenna system in the protected area of the LPS (LPZ 0<sub>B</sub> zone). This variant

is shown in Fig. 1, where also bonding and grounding is being addressed, while observing a separation distance according to EN 62305-3.

Fig. 1

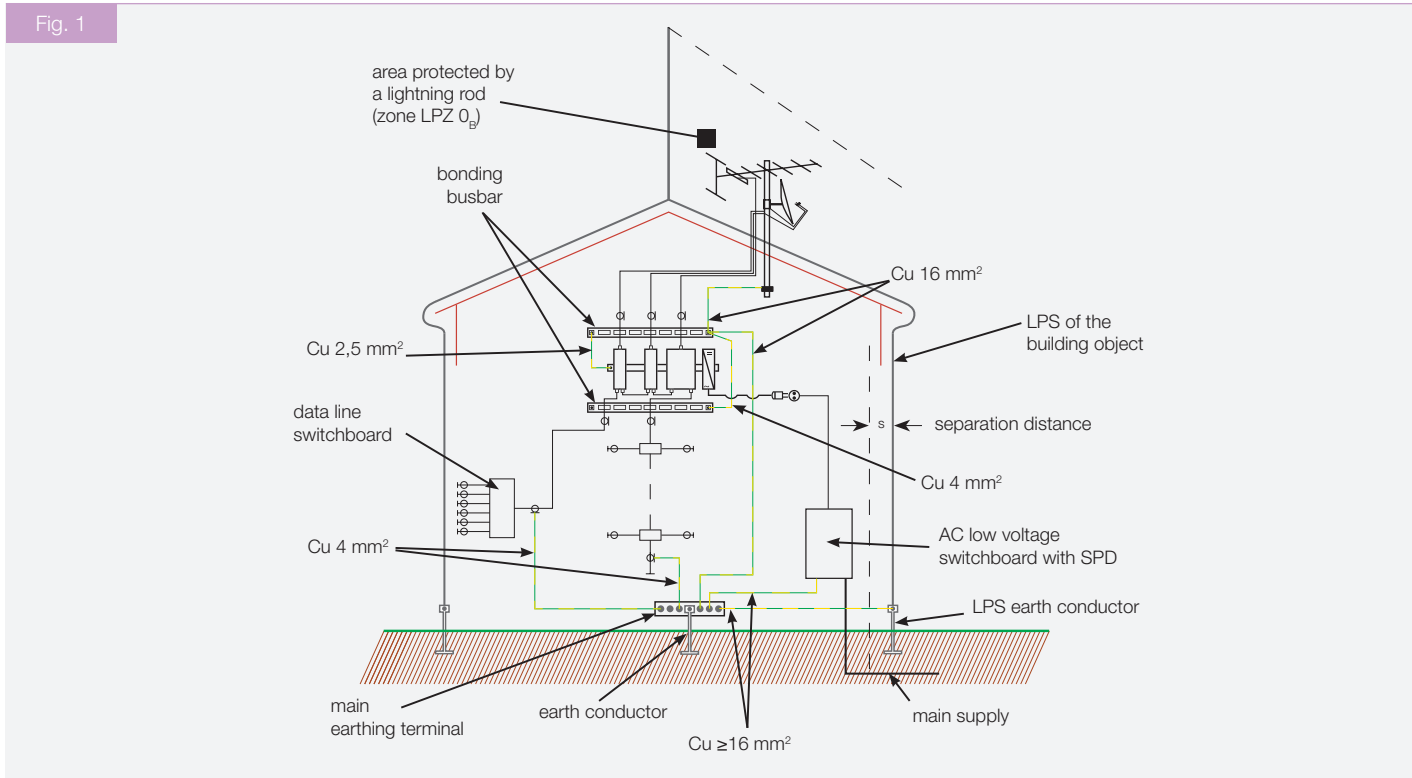

In case the existing LPS does not allow to place the antenna system in a space protected by LPS (the LPZ 0<sub>B</sub> zone) the situation can be

resolved as per Fig. 2, where the existing LPS is completed with an ATS in a way for the antenna system to be situated in the LPZ 0<sub>B</sub> zone.

Fig. 2

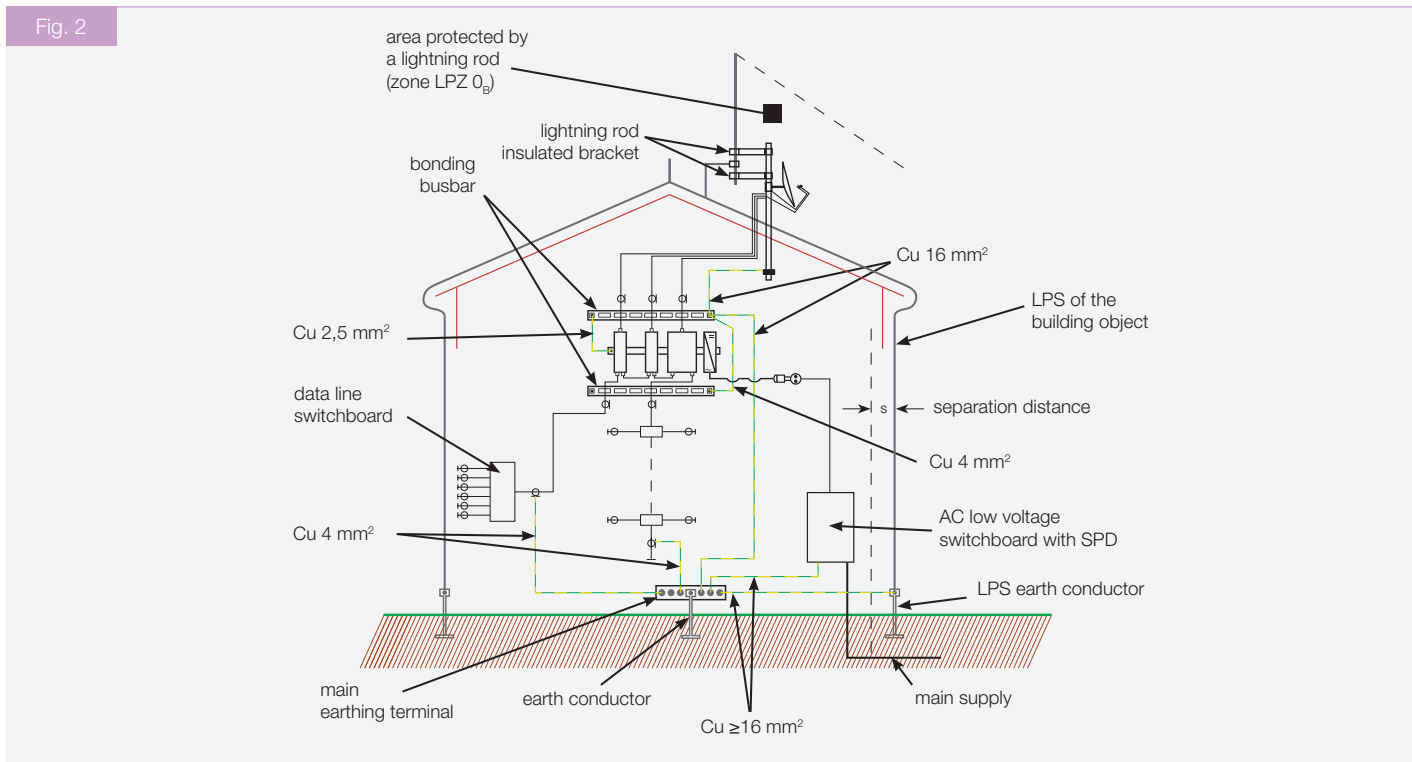

If no LPS (lightning rod) is installed in the building, then it is appropriate for the antenna system to have a specific LPS established as shown in Fig. 3.

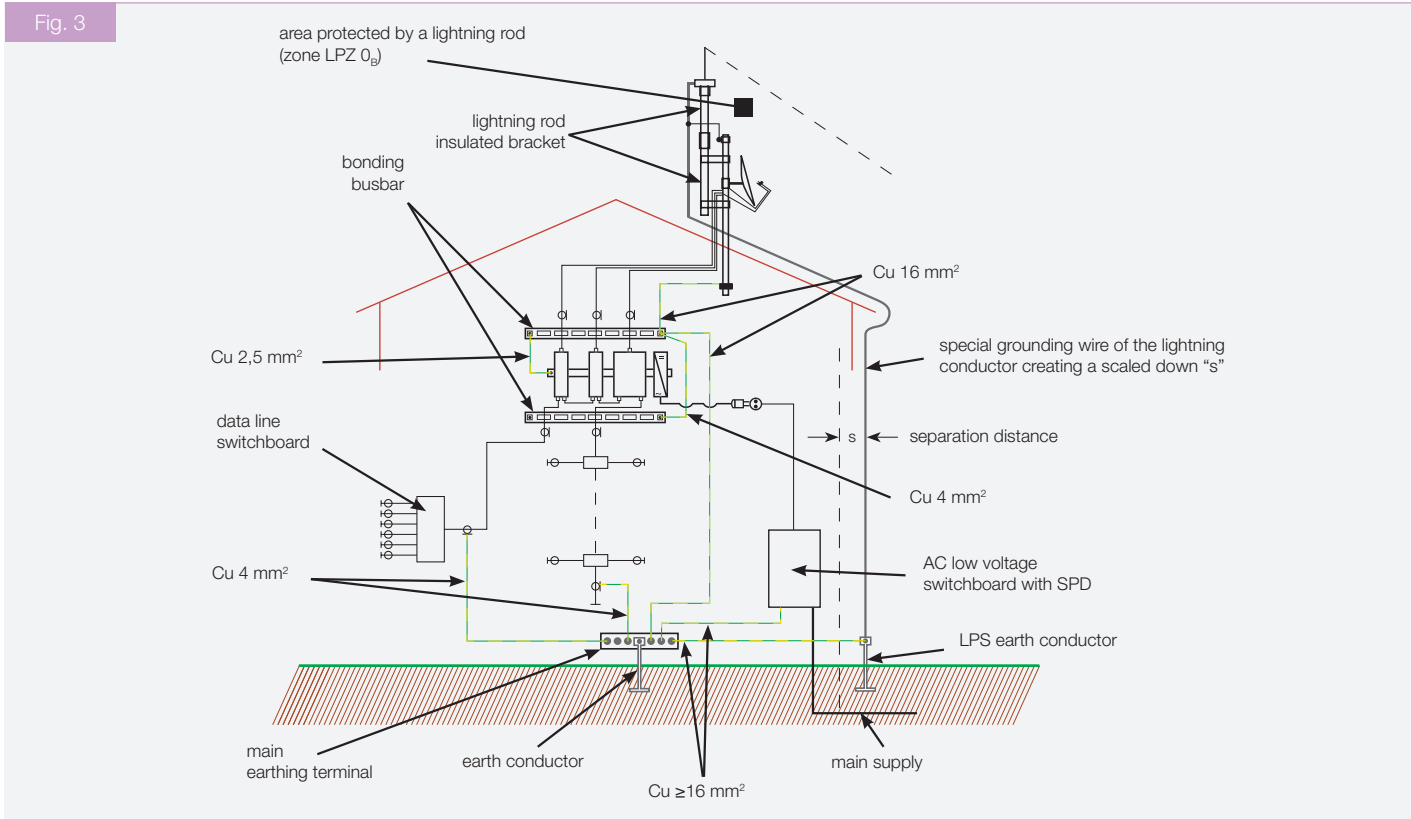

If the antenna system is located outside of the LPZ 0<sub>B</sub> zone, it means that it is now situated in an area no more protected by the LPS (LPZ 0<sub>A</sub> zone). Mounting example of such antenna system is

shown in Fig. 4. It can be seen that the ground conductors and bonding wires may not have a cross section less than 16 mm<sup>2</sup>.

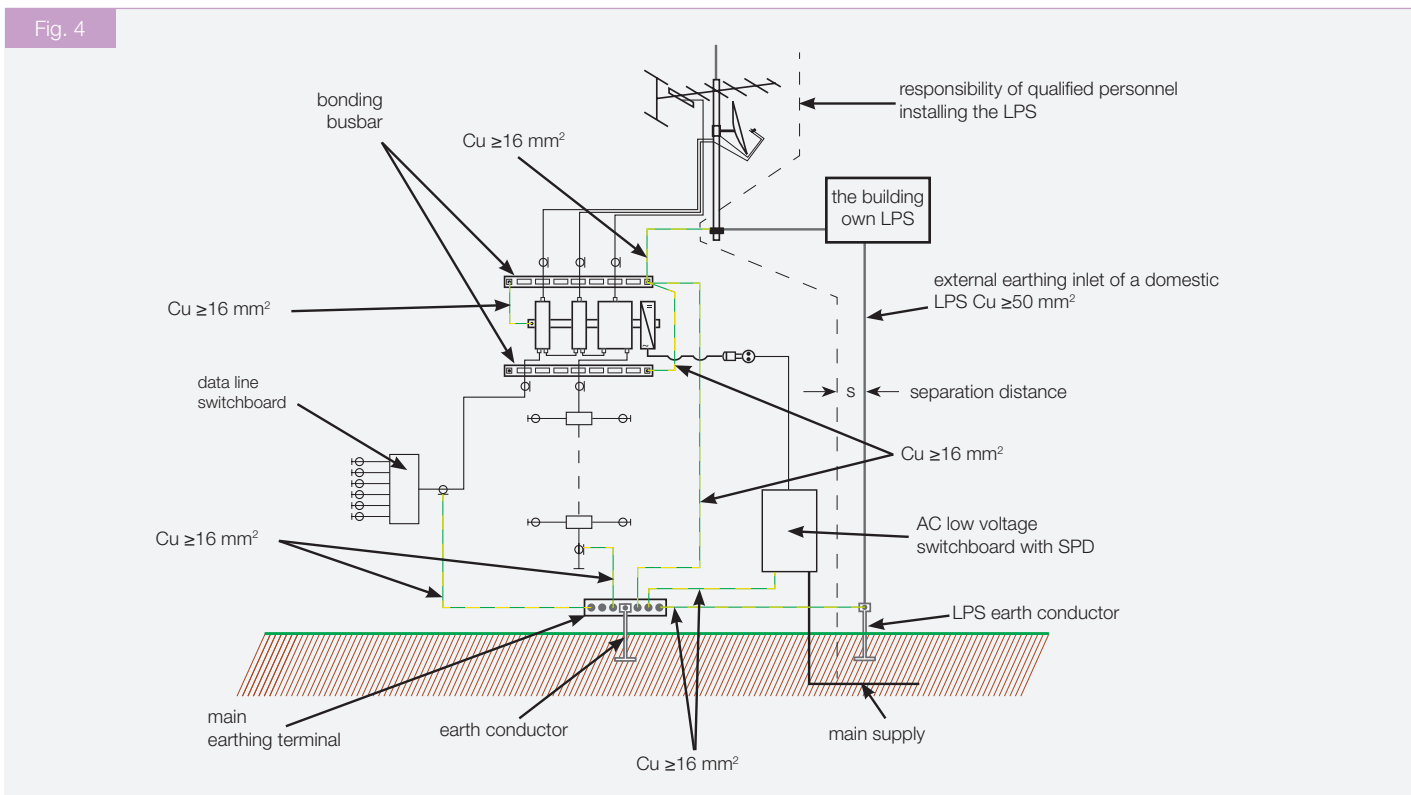

In family or apartment houses it is possible under the conditions on Fig. 5 to install antennas in the protected part of the building object, providing that the object is not higher than 45m for LPS class III ,

due to the possibility of side discharges (see EN 62305-3). In such a case grounding is not required because the increase of risk of a lightning strike for this way of installation is negligible.

Fig. 5

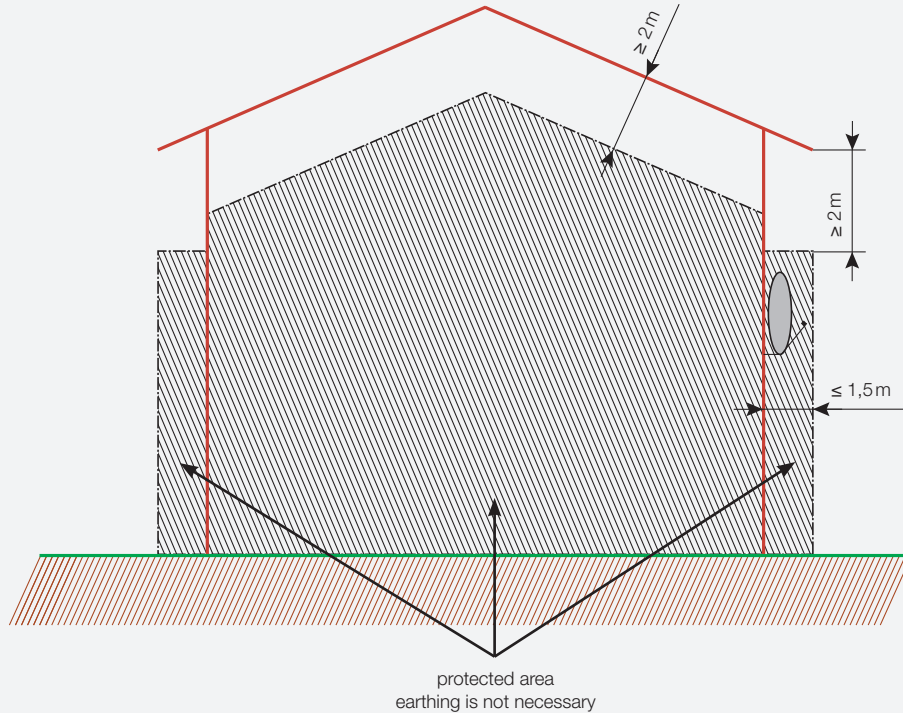

**b) Objects not provided with protection against lightning**

If the object has absolutely no a LPS and such a system cannot be installed for some reason, at least due to reasons shown in Fig. 3, the antenna mast has to be grounded, including the equipotential bonding. In terms of conditions this variant can be split up as follows:

1. If the installation of an LPS is not mandatorily required by local authorities, or if risk assessment data are not available or applicable, the mast and external coaxial cables (shielding) must be grounded. Yet it is always advisable to perform a risk assessment. Example of a grounding and bonding for this specific case is shown in Fig. 6

Fig. 6

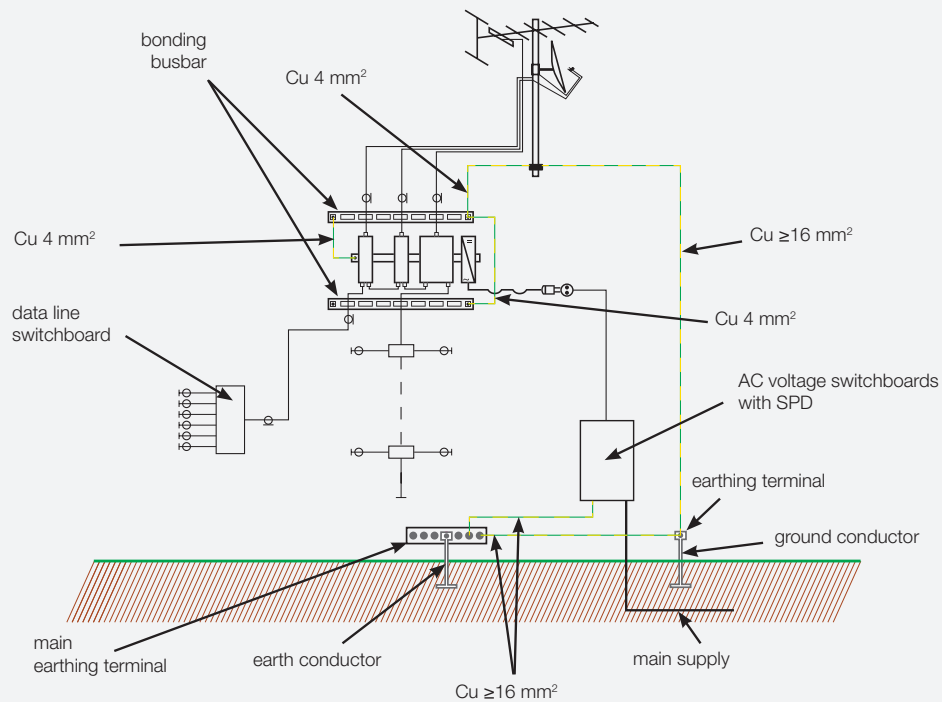

2. If it is found by calculation that the risk for the R building is less than or equal to the maximum  $R_T$  risk level which still can be tolerated, then lightning protection is not required. An example of such a design is shown in Fig . 7

Fig. 7

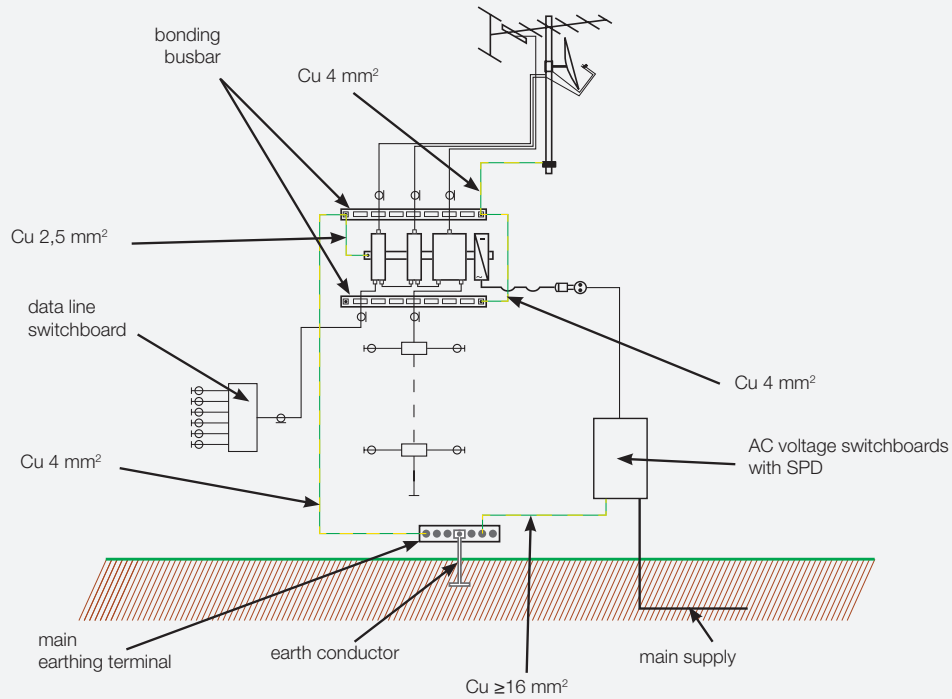

3. If despite all the measures implemented (bonding, SPD, discharge wires - for details see EN 60728-11 ed . 2 ), the condition  $R > R_T$  is still true, it is then necessary to first install the lightning conductor by an LPS expert and only then install the antenna system.

Verification of compliance with the requirements on LPS protection after finishing the installation of the antenna is conducted as per EN 62305-3, chapter 7.

## Overvoltage Protection

Present-day technological equipment is threatened by electromagnetic fields originating from distant lightning strikes or disturbances at the MV and HV and is becoming more sensitive to unwelcome induced voltages induced on antenna systems and coaxial lines.

At transfer points, system outlets, cable network stations or subscriber device inputs (e.g. at a satellite receiver, TV etc.), high voltages may appear which can destroy this technology.

Protection of engineering equipment from induced voltages is performed by equipotential bonding using surge protective devices (SPD) which provide for temporary equalization of potentials between the middle conductor and shielding (coaxial cable), or in web-based systems in which case an equipotential cable is placed in between the UTP (STP) antenna system and the respective cable cores for voltage balancing purposes.

The basic principle of protection of technological equipment against unwanted induced voltages is shown in Fig. 8. Here it is shown that it is not enough to deal with just the signal (weak current) part, but to address the power heavy current) part at the same time (see the set of EN 62305 standards).

If the protection is done to protect only the signal or power supply part, then such a protection is not efficient enough and the device, despite the resources spent, has a great chance to be destroyed. Fig 9 shows the principle of overvoltage protection for larger systems

In either of the cases it is necessary for the coaxial cables to be grounded at the entry to the building object (transition point LPZ0 - LPZ1 ) (cable metal shielding). This earthing is done through an earthing set which must be weather and waterproof.

Fig. 8

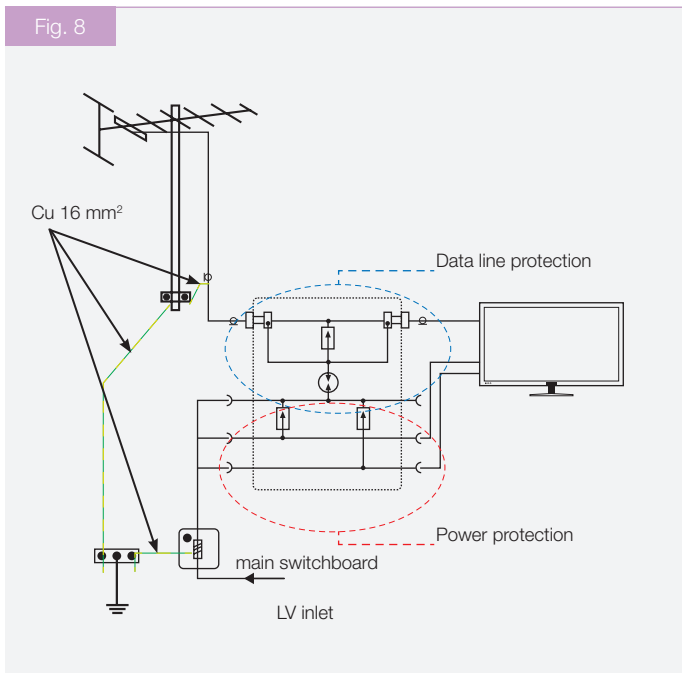

Fig. 9

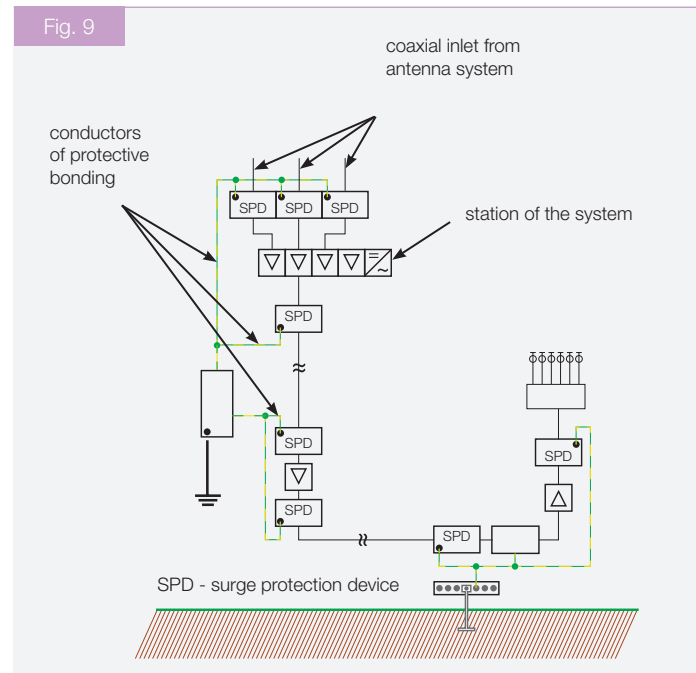
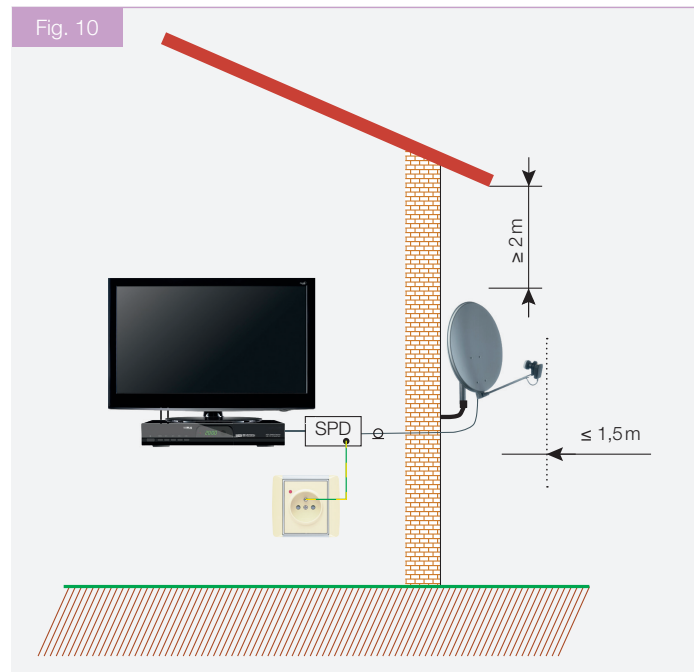

Fig. 10 shows an overvoltage protection arrangement in a situation where earthing is not required (see Fig. 5), and the coaxial line is not being earthed as well. It is a typical arrangement for apartment or family houses.



## Surge protection for transceivers

There are very long antenna down-leads in radio transmission systems exceeding the height of the buildings and are directly exposed to atmospheric discharges (lightning). This applies, of course, to antennas themselves. Although radio transmission systems are using cables of coaxial design (coaxial down-leads) which from the engineering point of view feature better properties than multiple-core down-leads in terms of electromagnetic compatibility (eg. UTP, STP cables ) used eg. in wireless Internet technology for receiving antennas and data transmissions.

Transients, which become induced on the lines, can get through these down-leads to sensitive interfaces and cause damage to transmitting and receiving equipment installed in the building.

Overvoltage protection is meaningful not only for directional transmitting radio equipment and mobile radio systems, but also for video monitoring and inspection systems, and in private sector, e.g. in satellite TV receivers.

Safety and reliability of transmitting and receiving devices of any type, in addition to conventional lightning protection (lightning rod), is decisively increased by suitable surge protections.

The aim of these measures is to significantly increase the usability and operational readiness of relevant technological systems.

The principle of protection of technological units, both against atmospheric phenomena (lightning strike) and against induced surges into the down-leads of single antennas, is shown in Fig. 11, where the down-leads of large antenna systems are grounded at the entry into a technological object. On the LPZ  $0_B$  - LPZ 1 boundary the down-leads are further equipped with appropriate coaxial protections to equalize dangerously high potential differences arising between the inner conductor and cable sheathing.





Fig. 11

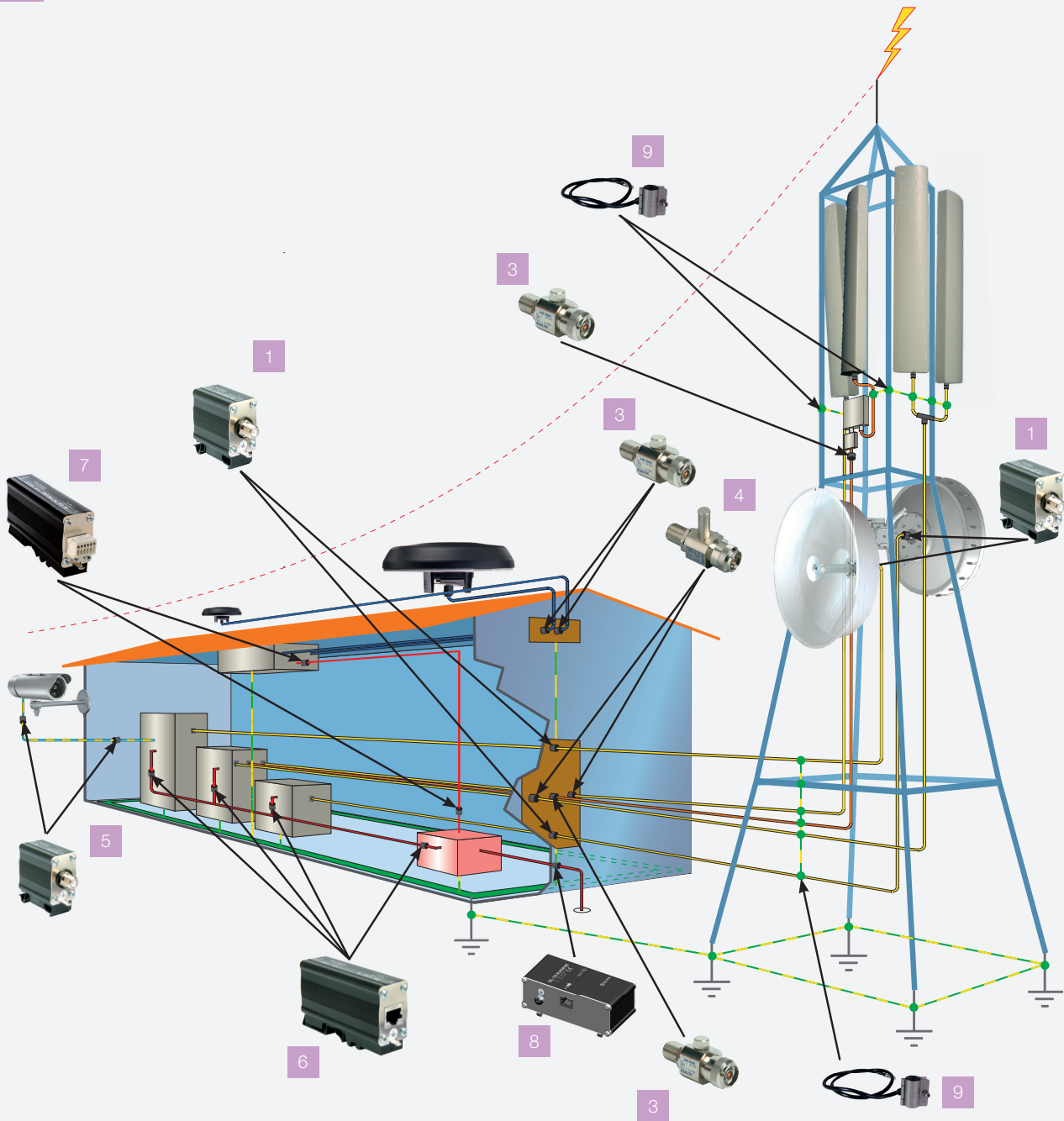

The following figure (Fig. 12) shows two basic variants of receiving antenna systems for family houses. If it is the case shown in Fig. 10 in which the antenna is situated in line with conditions described in Fig. 5, the coaxial protection - lightning arrester – is not necessary to be used, instead simple fine coaxial protection is sufficient .

In case the antenna system is mounted on the roof, it is necessary to use a coaxial protection - lightning arrester. In receivers (TV, sat-

ellite receiver), instead of using fine coaxial protections (see Fig. 12) it is more suitable to use combined adapters. As for TV terrestrial broadcasting TV-OVERDRIVE is more suitable, for satellite broadcasting it is TV-OVERDRIVE which is of advantage.. The advantage of these adapters is that they combine both power protection technology 230 V AC and coaxial (antenna) input protection.

Fig. 12

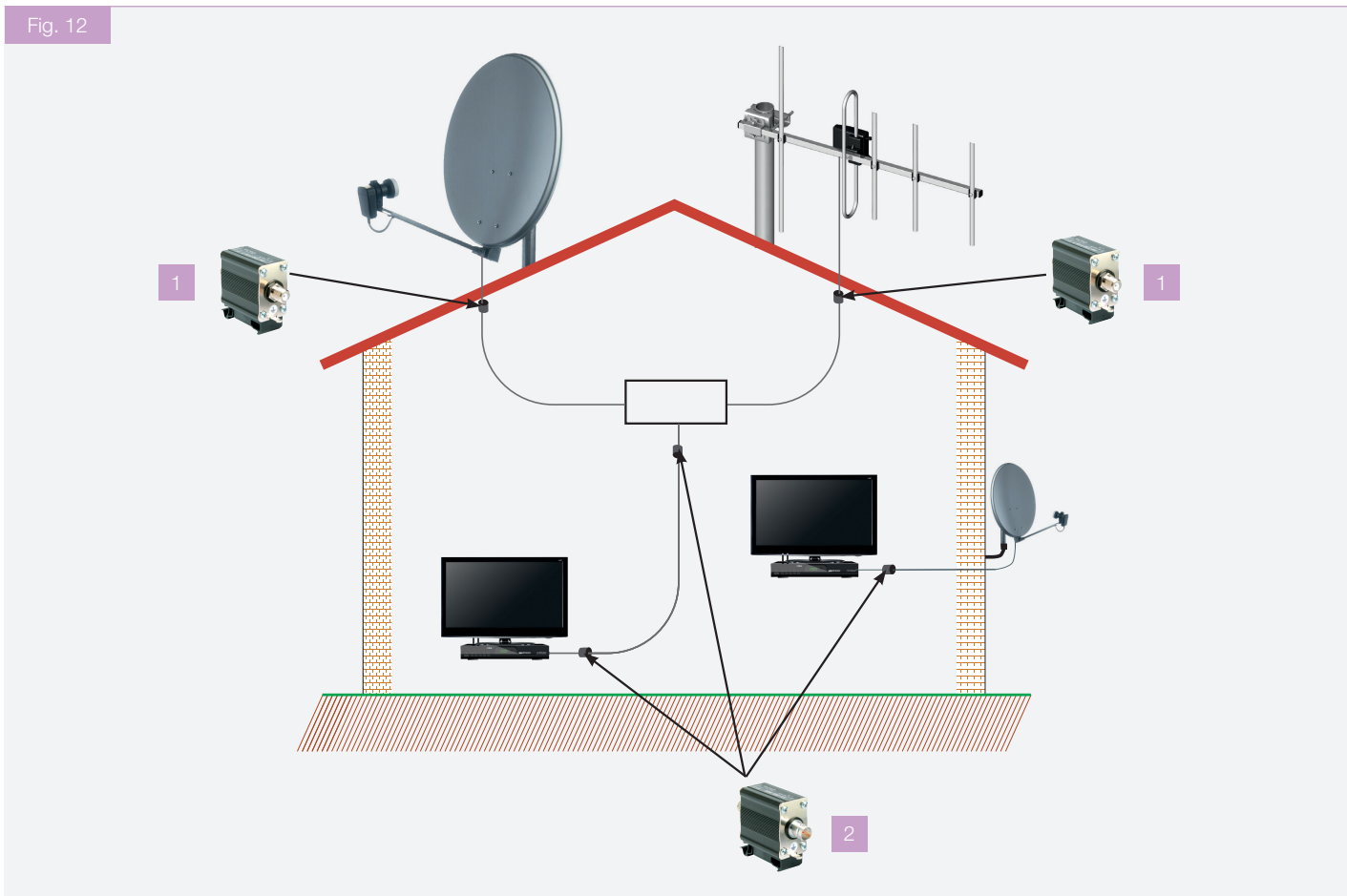

## Overview of products used in diagrams



**FX** – Multi-purpose protection of coaxial lines with a frequency range of 0 to 2.15 GHz can be used wherever it is necessary to re-tune the system in the zone concerned. It can also be used for coaxial cables with power supply. The connectors can be of BNC or F type.

The protection is installed at the boundary of LPZ 0<sub>A</sub> and LPZ 1 zones.

A typical application example is a satellite receiver in households.



**SX** – Fine surge protection intended for use at TV and SAT inputs, with the possibility of provision of power supply or control voltages up to 28 V DC via coaxial cable.



**HX** – Surge protection intended to protect coaxial and telecommunication equipment in the frequency range 0 to 3.5 GHz, which also allows for transfer of AC or DC power via coaxial line. It is installed at the transition point from LPZ 0<sub>A</sub> to LPZ 1 zones.



**ZX** – Highly efficient protection with the lambda/4 technology, intended to protect coaxial lines and telecommunication equipment. Installed at the boundary of LPZ 0<sub>A</sub> and LPZ 1 zones. For use in technologies with fixed frequencies and not suitable for combined distributions of RF signal and power supply or control voltages.



**VL** – Combined coarse and fine protection intended to protect coaxial lines of CCTV camera systems.



**DL-Cat. 5e a DL-Cat. 6** – protections are intended to protect data lines used in radio transmission systems. Suitable for various types of data transmissions.

DL -Cat. 5e/6 protections serve to protect Cat. 5e/6 data signals, respectively. Either of the protections are capable to transfer data only.



**DL-Cat. 5e POE, DL-Cat. 5e POE plus and DL-100 POE xx** – are used if also power supply is to be transferred, in addition to Cat. 5e data transmission.

In the case combined data and power is to be transmitted, protections of DL -Cat. 6-60 V or DL - 1G 60 V will be used for Cat. 6 data transfer.



**DL-1G-RJ45POE** – Special Data Protection Cat. 6, intended to be installed on the boundary of LPZ 0<sub>B</sub> and LPZ1 zones.



**Earthing kit** – Used for additional earthing of outer conductors (shielding) of coaxial cables. In households using of combined protections (adapters) is advisable, for 230 V power supply lines and coaxial cables, since by using them we avoid the necessity of earthing the respective SPDs. Examples of these adapters are shown in Fig. 10 for use in ground (terrestrial) broadcasting (DVB - T), with IEC connectors, or Fig. 11 for satellite (DVB - S) broadcasting with F connectors.



Plug adapter with integrated low-voltage surge protection or noise-suppressing RF filter, combined with surge protection of an antenna down-lead, for use on television sets to protect them from pulse overvoltage or from RF interferences.



Plug adapter with integrated low-voltage surge protection or RFI filter, and with a surge protection to protect aerial down-lead starting from a dish antenna. The adapter is designed to protect satellite sets against pulse overvoltages or RF interferences.



**SALTEK TRADE s.r.o.**  
Vodňanská 1419/226  
198 00 Praha 9 - Kyje  
Czech Republic  
Phone: +420 272 942 470  
Fax: +420 267 913 411  
E-mail: [trade@saltek.cz](mailto:trade@saltek.cz)  
[www.saltek.eu/en](http://www.saltek.eu/en)

Distributor:

--